

**TOP VIEW**

SCALE 1:8

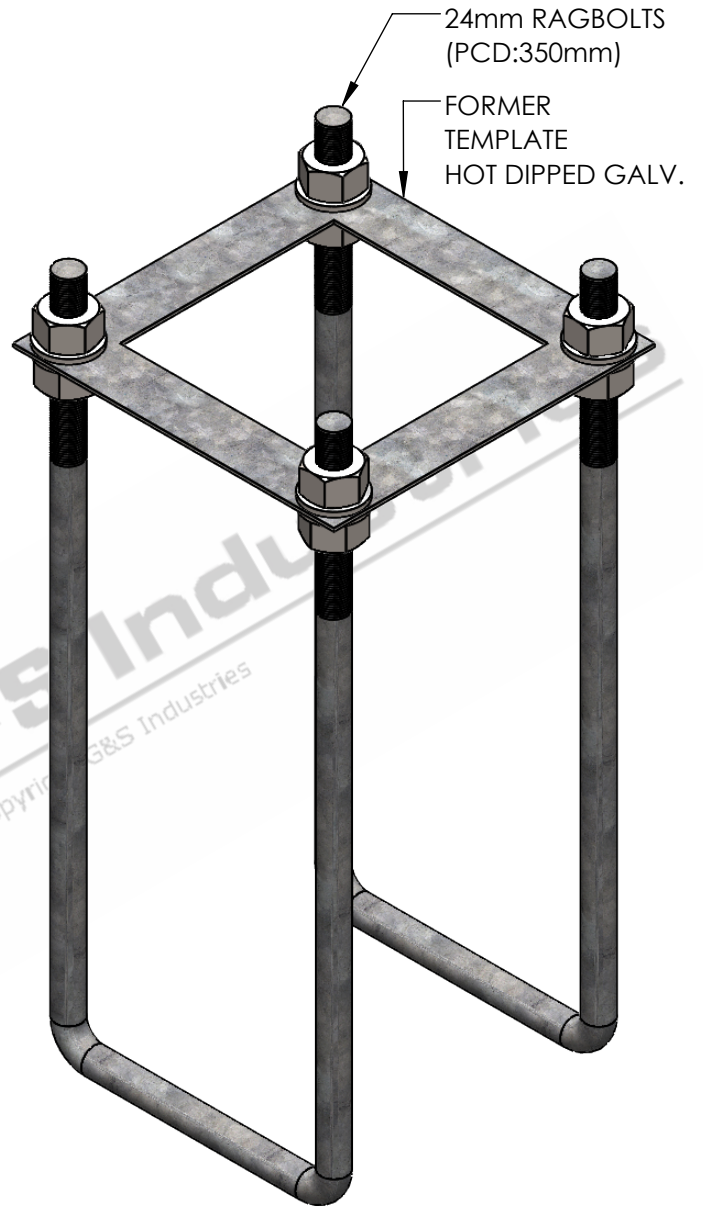

**ISOMETRIC VIEW**

SCALE 1:5

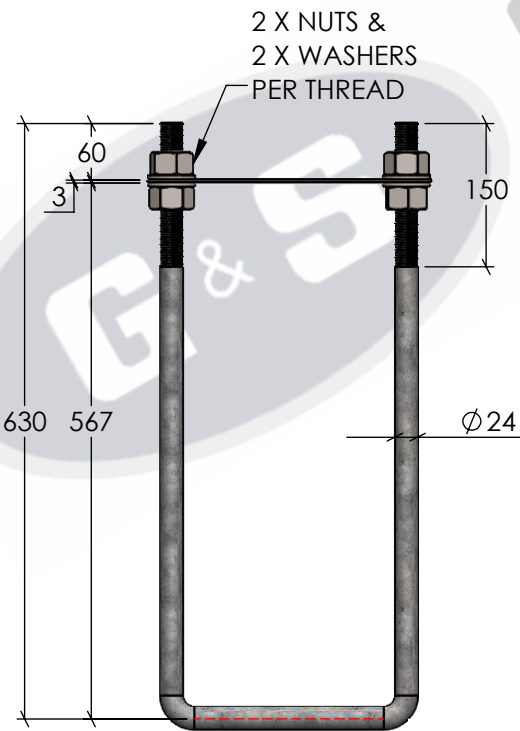

**SIDE VIEW**

SCALE 1:8

**STANDARDS**

- ALL PRODUCTS TO CONFORM TO THE FOLLOWING AUSTRALIAN STANDARDS.
- \* AS 1170.2 Structural design actions - Wind actions.
  - \* AS 1554(set) Structural steel welding set.
  - \* AS 2159: Piling - Design & Installation.
  - \* AS 2870: Residential slab footings - Construction.
  - \* AS 3600: Concrete structures.
  - \* AS 3678: Structural steel - Hot rolled plates, floorplates and slabs.
  - \* AS 4680: Hot dip galvanized (Zinc) Coatings on fabricated ferrous articles.
  - \* AS/NZS 4671: Steel reinforcing materials.
  - \* AS/NZS 4600: Cold formed steel structures.



**G & S Industries**

97 GUTHRIE STREET,  
OSBORNE PARK W.A. 6017  
PH : +6108 9446 8044  
EMAIL: sales@gsindustries.com.au  
WEB: www.gsindustries.com.au

**PROPRIETARY AND CONFIDENTIAL**  
THE INFORMATION CONTAINED IN THIS DRAWING IS THE SOLE PROPERTY OF G&S INDUSTRIES. ANY REPRODUCTION IN PART OR AS A WHOLE WITHOUT THE WRITTEN PERMISSION OF G&S INDUSTRIES IS PROHIBITED.

SCALE: AS SHOWN PRODUCT WEIGHT: 11.6kg.

PRODUCT FINISH: HOT DIPPED GALVANIZED

CUSTOMER APPROVAL :

CUSTOMER NAME / PROJECT :

	NAME	DATE
DRAWN	N. A.	14.10.2022
CHECKED	S. G.	14.10.2022
APPROVED	R. G.	14.10.2022

**COPYRIGHT**  
THIS DOCUMENT IS PRODUCED BY G&S INDUSTRIES  
MUST NOT BE COPIED, TRACED, REPRODUCED,  
OR LENT WITHOUT WRITTEN CONSENT

PART NUMBER :		<b>R24/4/350</b>	
TITLE :		<b>24MM 4 BOLT 350 PCD RAGBOLT ASSEMBLY</b>	
SIZE	DWG. NO.	REV.	
<b>A4</b>	<b>ZLRG2222</b>	<b>0</b>	