

1

2

3

4

A

A

B

B

C

C

D

D

E

E

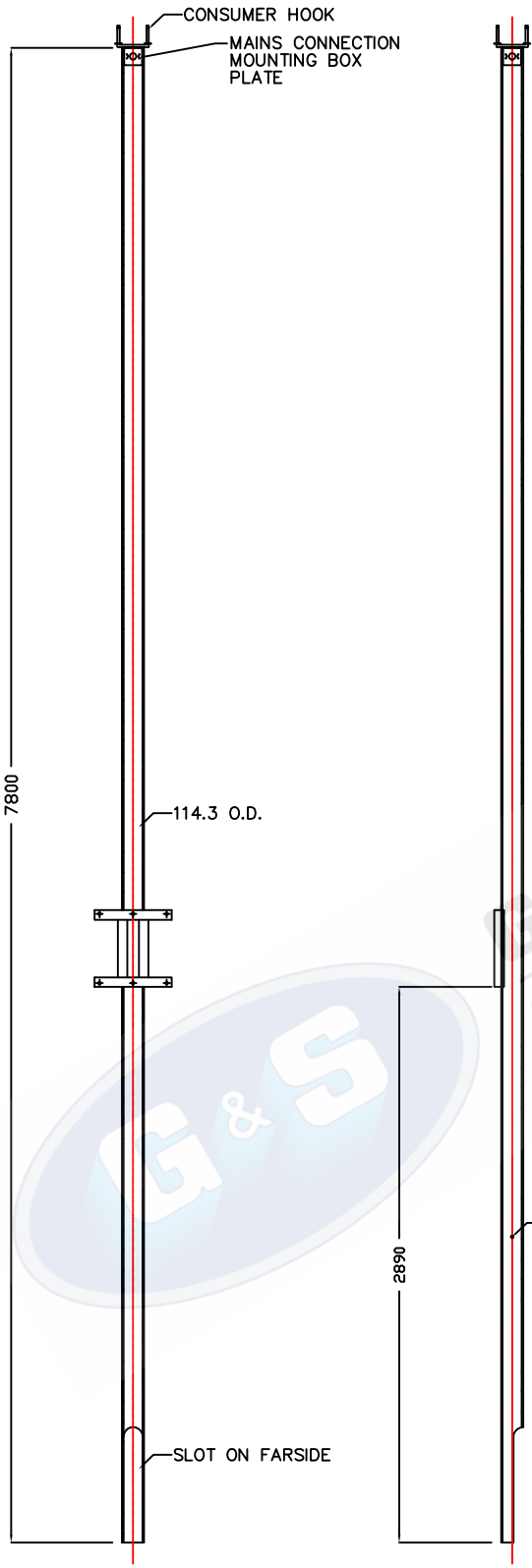

**FRONT VIEW**

**RIGHT VIEW**

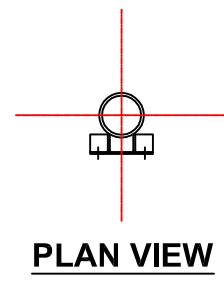

**PLAN VIEW**

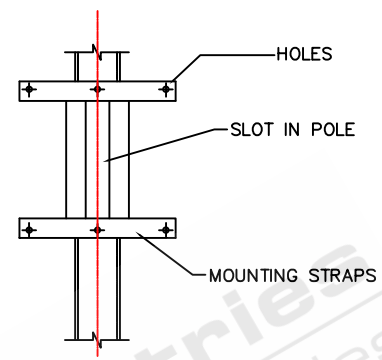

**FRONT VIEW  
(DETAIL) OF TOP**

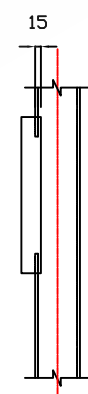

**RIGHT VIEW  
(DETAIL) OF TOP**

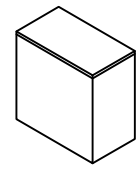

450 x 450 x 250mm  
METER BOX

- STANDARDS**  
 ALL PRODUCTS TO CONFORM TO THE FOLLOWING AUSTRALIAN STANDARDS  
 \* AS 1170.2: Structural design actions – Wind actions.  
 \* AS 1302: Geometrical product specifications indication of surface texture in technical production documentation.  
 \* AS 1554(set): Structural steel welding set.  
 \* AS 2159: Piling – Design & Installation.  
 \* AS 2870: Residential slab footings – Construction.  
 \* AS 3600: Concrete structures.  
 \* AS 3678: Structural steel – Hot rolled plates, floorplates and slabs.  
 \* AS 4680: Hot dip galvanized (Zinc) Coatings on fabricated ferrous articles.  
 \* AS/NZS 4671: Steel reinforcing materials.  
 \* AS/NZS 4600: Cold formed steel structures.  
 \* AS/NZS 4676: Structural design requirements for utility services poles.



G&S Industries

97 GUTHRIE STREET, OSBORNE PARK W.A. 6017  
PH (08) 9446 8044. (08) 9446 8266  
FAX (08) 9446 5456

JOB NO.	DATE:	DESIGN:	DRAWN:
POWER CONNECTION COLUMN MC7.8BF114 600013		Z.L.	Z.L.
		CHECKED:	APPROVED:
		R.G.	Y
		LAST REVISED:	SCALE:
		4 SEPT '06	NTS
		DRAWING:	REVISION:
		ZLRG2025	01

1

2

3

4