

1 2 3 4

A

B

C

D

E

A

B

C

D

E

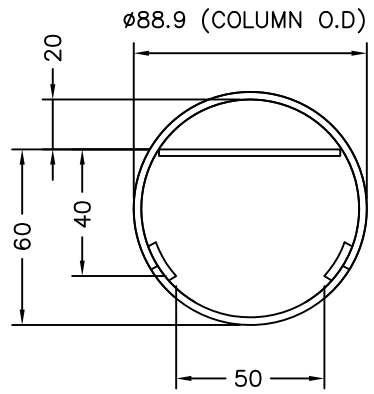
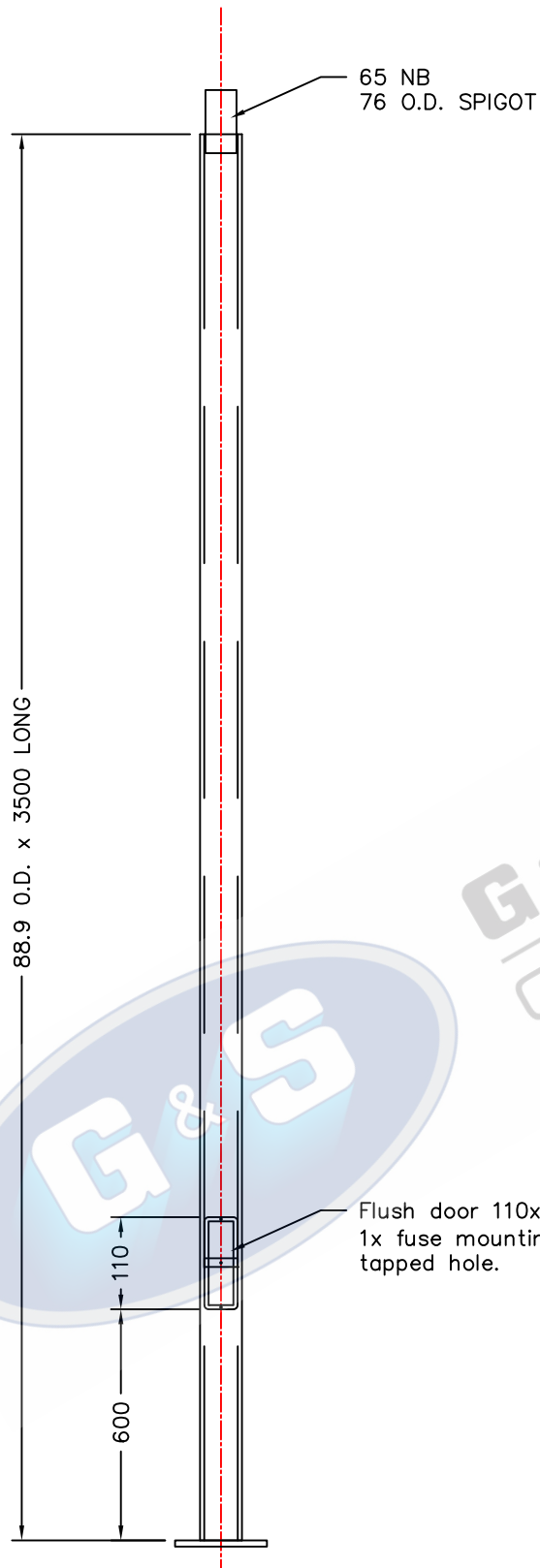

DOOR CLEARANCES

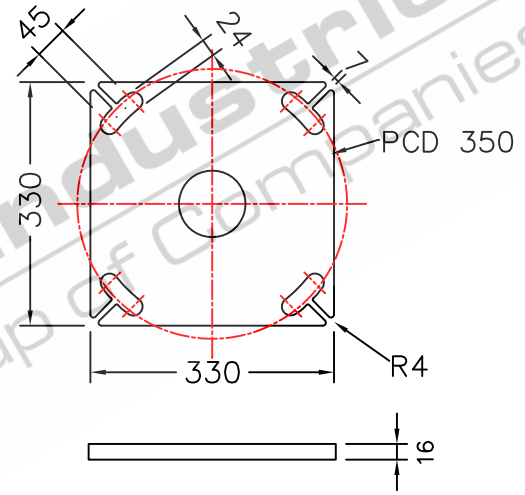

BASEPLATE DETAILS

Flush door 110x50 clear opening with  
1x fuse mounting strap C/W 6mm  
tapped hole.

- STANDARDS**  
ALL PRODUCTS TO CONFORM TO THE FOLLOWING AUSTRALIAN STANDARDS
- \* AS 1170.2: Structural design actions - Wind actions.
  - \* AS 1302: Geometrical product specifications indication of surface texture in technical production documentation.
  - \* AS 1554(set) Structural steel welding set.
  - \* AS 2159: Piling - Design & Installation.
  - \* AS 2870: Residential slab footings - Construction.
  - \* AS 3600: Concrete structures.
  - \* AS 3678: Structural steel - Hot rolled plates, floorplates and slabs.
  - \* AS 4680: Hot dip galvanized (Zinc) Coatings on fabricated ferrous articles.
  - \* AS/NZS 4671: Steel reinforcing materials.
  - \* AS/NZS 4600: Cold formed steel structures.
  - \* AS/NZS 4676: Structural design requirements for utility services poles.



97 GUTHRIE STREET OSBORNE PARK W.A. 6017  
PH. (08) 9446 8044, (08) 9446 8266  
FAX (08) 9446 5456

JOB No	DATE:	DESIGN# SG	DRAW# ZL
CIRCULAR COLUMN C88B3.5 3.5m POST TOP COLUMN BASEPLATE MOUNTED 650034		CHECKED# RG	APPROVED Y
		LAST REVISED: 4 SEPT '06	SCALE NTS
		DRAWING ZLRG2091	REVISION 01

1 2 3 4